

M-SPORT



PUMA Rally1

1/8 RALLY RTR

WORLD RALLY TEAM



Instruction Manual



POWERED BY

HOBBYWING SAVÖX

CEN

RACING



PRECAUTIONS FOR SAFE ENJOYMENT OF YOUR R/C CAR

PRECAUTIONS FOR SAFE ENJOYMENT OF YOUR R/C CAR

- For children under the age of 14, parental guidance is recommended when running.

ASSEMBLY PRECAUTIONS

- For children under the age of 14, parental guidance is recommended when running.
- Check the contents carefully before assembly. Please contact Customer Support if you happen to notice any defective or missing items.
- You will find the assembly process much easier by carefully reading through the manual, and familiarizing yourself with the instructions.
- Many different tools are required during assembly. For safety purposes, please use suitable tools. Exercise extra caution when using a sharp tool such as a hobby knife.
- Many different materials are used for the parts. Use extra care when handling parts with sharp edges, such as machined metal parts.
- When cutting plastic parts, watch for any flying parts.
- Try to assemble any rotating parts or drivetrain parts as smooth as possible.
- Bundle wires neatly away from the ground or any moving drivetrain components. Make sure that all wires are properly connected to prevent shorting.
- Unnecessary modifications may be unsafe and hinder performance.

PRECAUTIONS BEFORE RUNNING

- R/C cars some models may exceed speeds of 40km per hour. Practice common sense and run the car in open safe places, or R/C car tracks.
- Do not run the car on public roads with high amounts of traffic, or in areas that may cause an inconvenience to people in that area.
- R/C cars are controlled using a radio frequency. In a worst-case scenario. Radio interferences may cause loss of control.
- If others near you are running R/C cars, confirm that they are not running on the same frequency.
- R/C cars do not like water. Avoid running on rainy days, or areas with water puddles. Exposure of the electronics to water may cause loss of control or damage to the electronics.
- The drivetrain of an R/C car consists of many moving parts like gears, shafts, and tires. Avoid touching these areas when the battery is connected.

BEGINNING A RUN

1. Place the R/C car on a stand so the wheels are off the ground.
2. Confirm that the speed controller switch is OFF, and connect the motor and battery.
3. Extend the transmitter antenna and turn the switch ON. (It is unsafe to use a transmitter with low voltage. Make sure that the transmitter batteries are good before running)
4. Turn the speed controller switch ON.

FINISH A RUN

1. Turn the speed controller switch OFF.
2. Disconnect the battery.
3. Turn the transmitter switch OFF, and retract the antenna.

BATTERY

- (Carefully read the instruction included with the batteries.)
- When charging batteries, make sure that the surrounding area is void of anything highly flammable. Also avoid charging in high-temperature locations.
 - When charging batteries, frequently monitor the charging it catch on fire. If the battery reaches 50 degrees Celsius or more, stop charging.
 - Batteries will become hot after running. Continuous use of the battery pack may result in damage to the cells. Allow the battery too cool down before re-charging. Using a battery conditioner after running may prolong the life and performance of the battery.
 - Please do not discard old battery packs in the trash. Although inconvenient, please locate a battery disposal center.

MOTOR USAGE

- (Carefully read the instruction included with the motor.)
- Connecting a 7.2V battery directly to the motor can be very dangerous.
 - Choose a gear ratio that matches the power characteristics of the motor. Using a gear ratio unsuited to the characteristics of the motor will not only prevent the motor from performing at its optimum, but may even cause damage to the other electronics.
 - Motors will generally become very hot after running. Continuous running will reduce the life of the motor. Allow the motor to sufficiently cool between each run.

Instruction

We would like to thank you for purchasing CEN Racing vehicle. Please read the following instructions for best results. This manual contains many useful operating tips. Please hold on to this manual for future references.

Step-1 Charge Battery Pack

- Please charge your battery completely before attempting to operate your truck.

Step-2 Install Batteries

- Install 4 AA batteries into the transmitter following the polarity directed on the battery tray.

Step-3 Install and Connect Battery Pack

- Install your charged battery pack. Secure the battery with the mounting bracket and battery hold down lock. Connect the battery and speed controller plugs. Make sure they are pressed together firmly.

Step-4 Turn on Transmitter

- Turn on your transmitter by pushing the switch on the left side of the steering wheel to the on position. You will hear a short “beep” when its on and you should see blue LED light stay on the right side of the transmitter. If you hear short beep or beeping please replace your transmitter batteries immediately before operating your vehicle.

Step-5 Turn on your Truck

- You can start the truck by activating the on/off switch.
- **Always turn on the transmitter first before starting the truck**

Step-6 Testing Operation

- Before driving your truck, make sure everything is operating correctly. Make sure wheels turn left and right and the throttle responds correctly.

Step-7 Play and Have Fun

- Enjoy your CEN Racing radio-controlled model vehicle

Tools Required



1.5mm



2.0mm



2.5mm



Socket Wrench



Phillips Screwdriver
(Not included)

Equipment Required

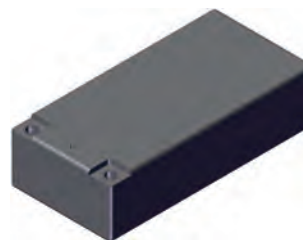

Battery
(Not included)

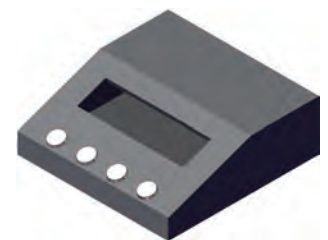

Battery Charger
(Not included)



Gears Grease
(Not included)



Silicone Oil
(Not included)



Threadlocker
(Not included)

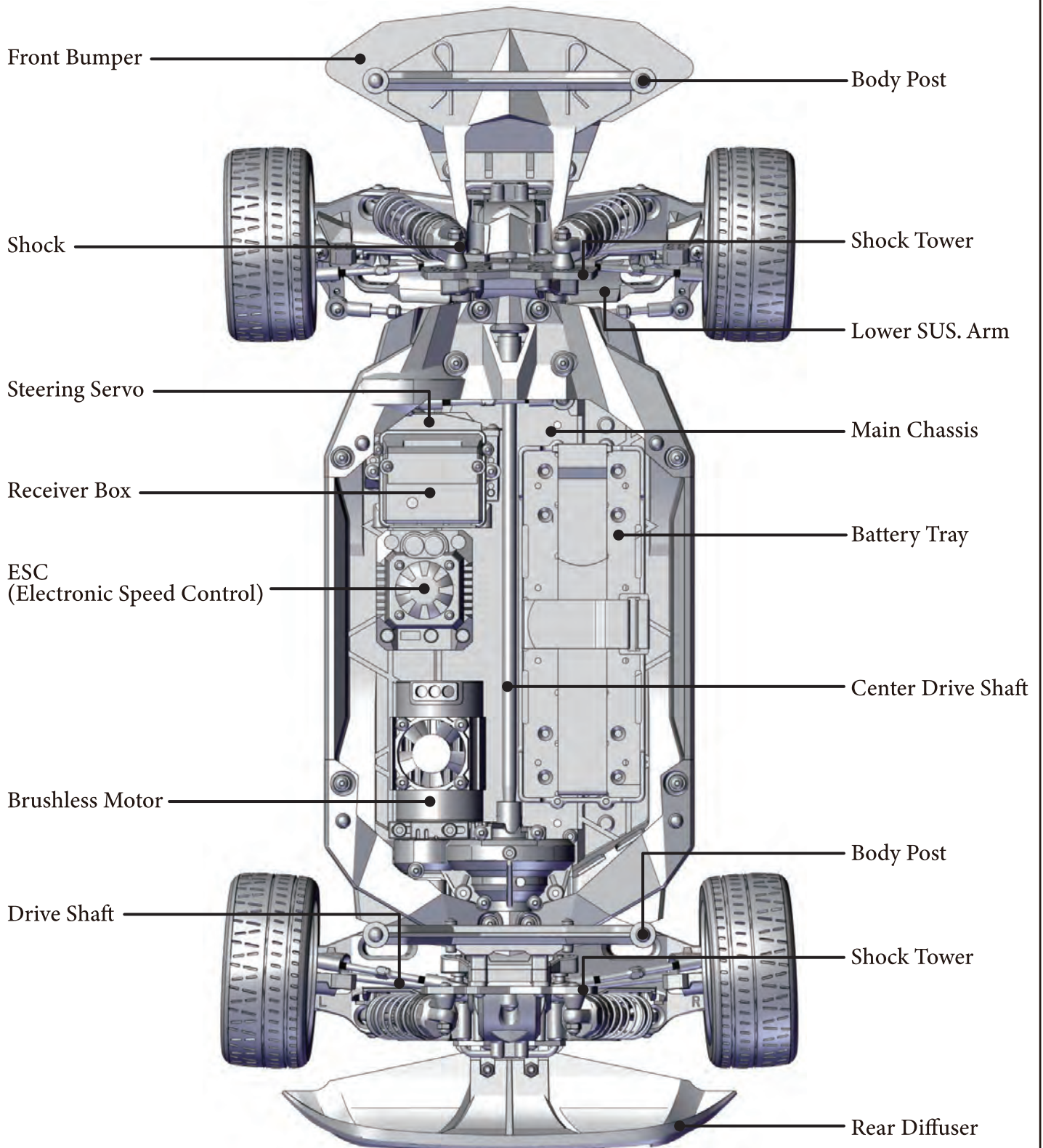

Electronic System

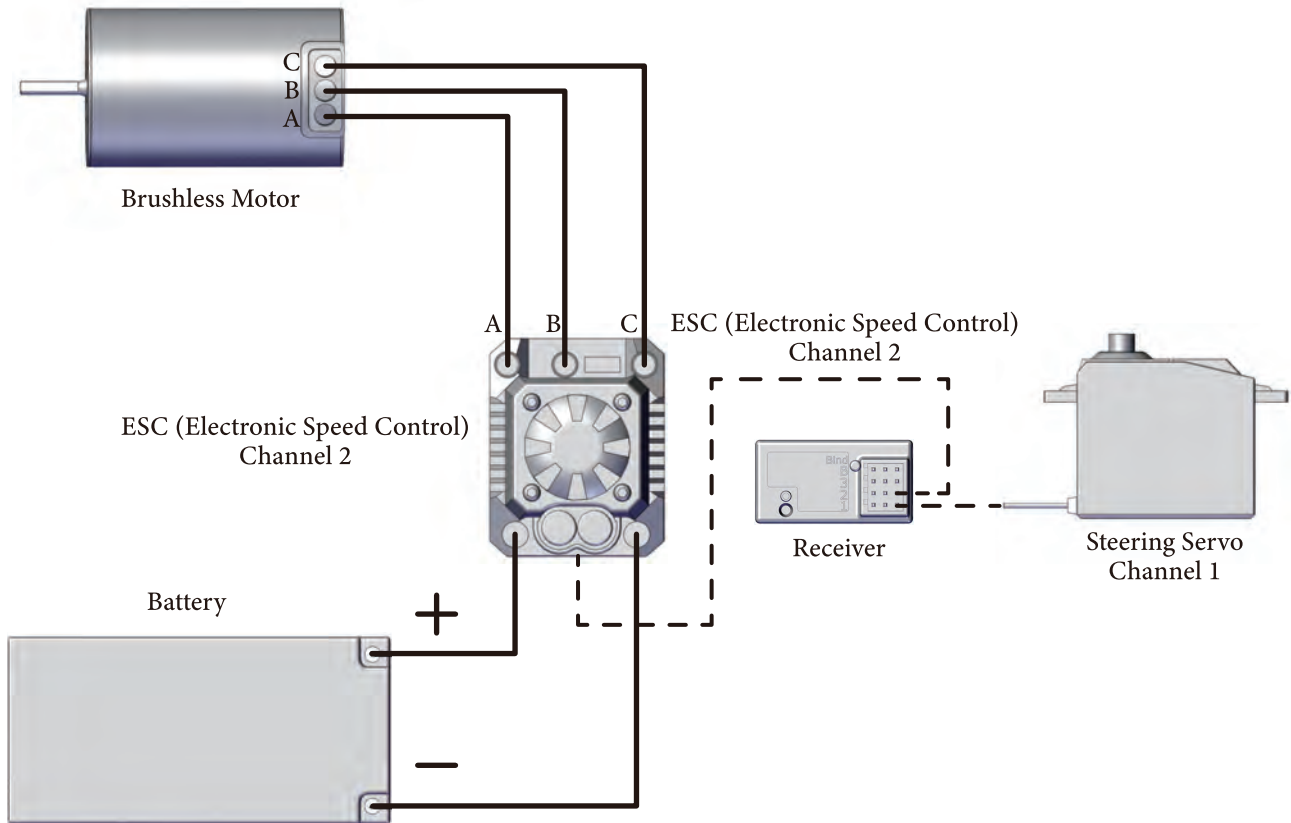

2.4G Radio Control System

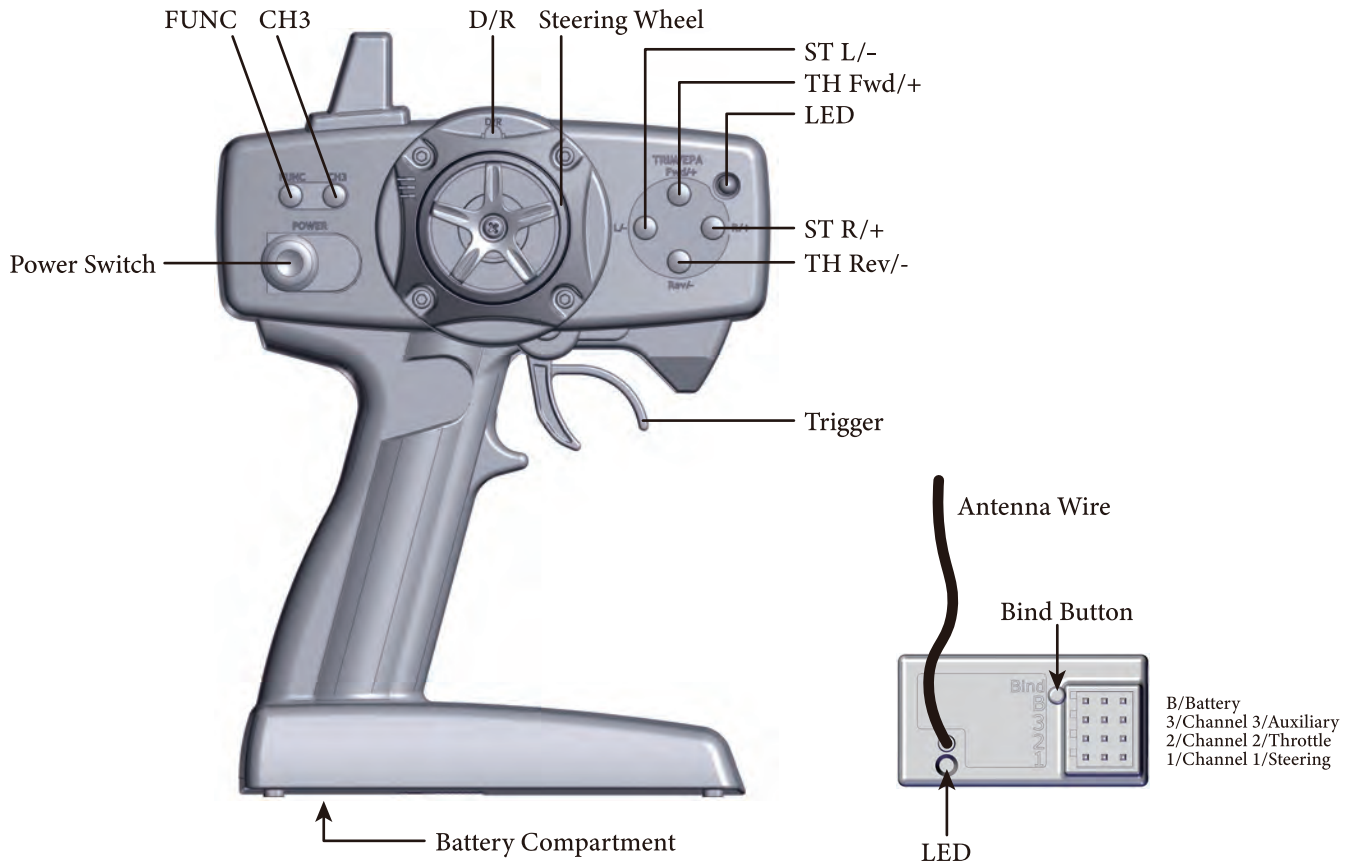

Install Batteries

1. Remove the battery cover from the transmitter
2. Install 4 AA alkaline dry cell batteries
3. Insert the 4 AA batteries according to the polarity
4. Replace the battery cover



Reciver Binding

1. Press and hold the "binding button" on the receiver
2. While holding the binding button, turn the vehicle power switch to On
3. The LED of the receiver will blink indicating that it is searching for a transmitter to bind with
4. Turn the transmitter power switch to On
5. Once the transmitter and the receiver are bound together, the receiver's LED light will turn solid
6. This may take up to 30 seconds, otherwise, repeat step 1 to 5.

Fail-safe Adjustment

1. Press and hold the receiver binding button until the LED light flashes
2. Adjust the throttle trigger and steering wheel to adjust the position
3. Press the binding button to program. Once the position are programmed, the LED light will flash and stay solid

Power Alarm

1. No Activity Alarm: When the steering wheel (ST), throttle trigger (TH) or any button is not operated for 15 minutes, a slow beeping alarm will sound to indicate that there has been no action and the power should be turned off.
2. Low Battery Voltage Alarm: A quick beeping alarm sounds and the power LED light will blink.

Bind Button

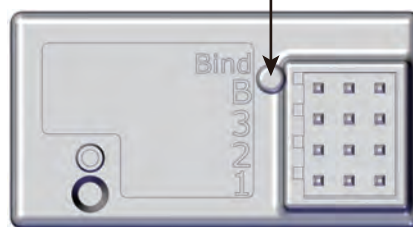

Basic Operation

CEN
RACING

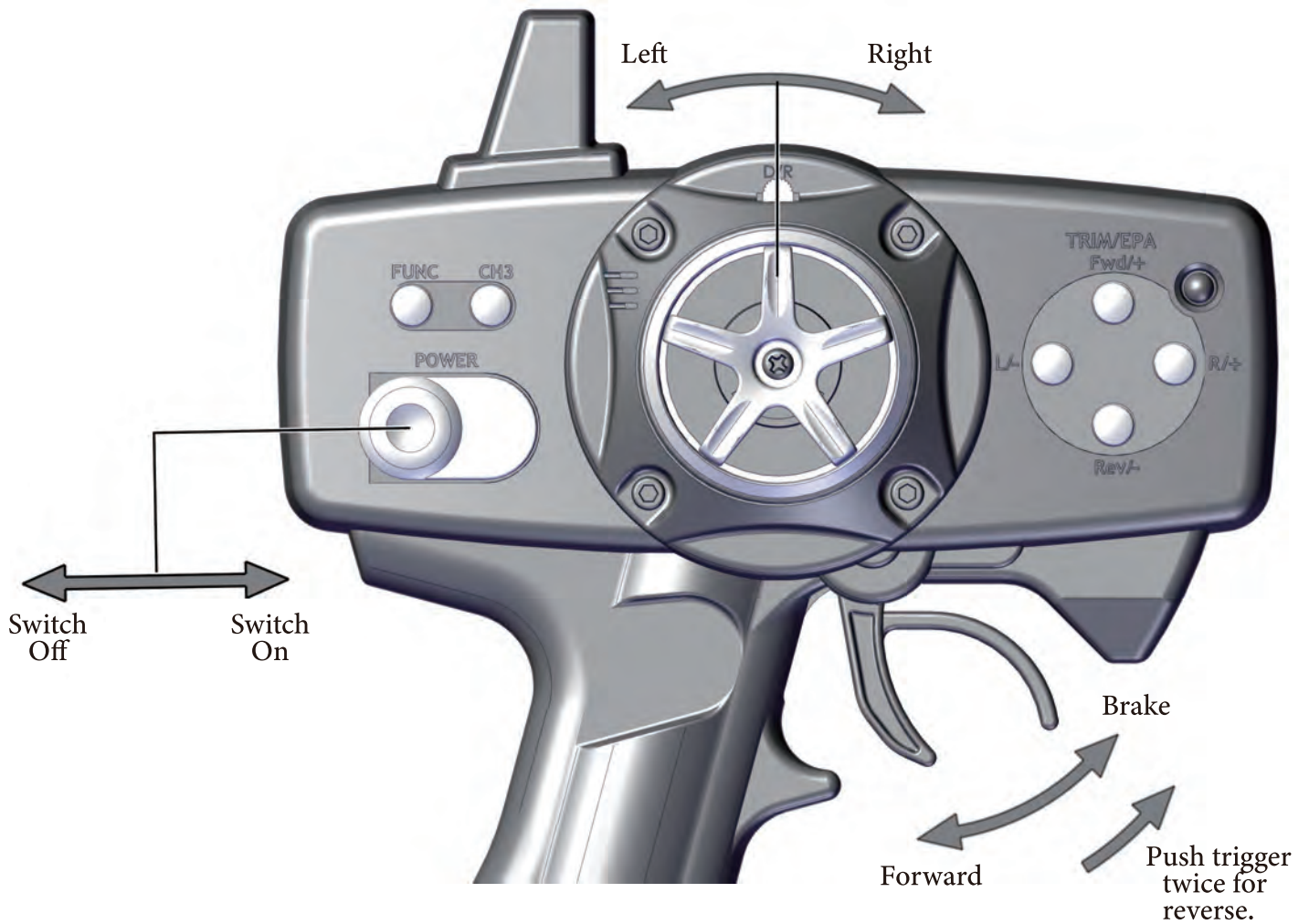

**For more transmitter details,
please refer to the AMP30 user manual.**

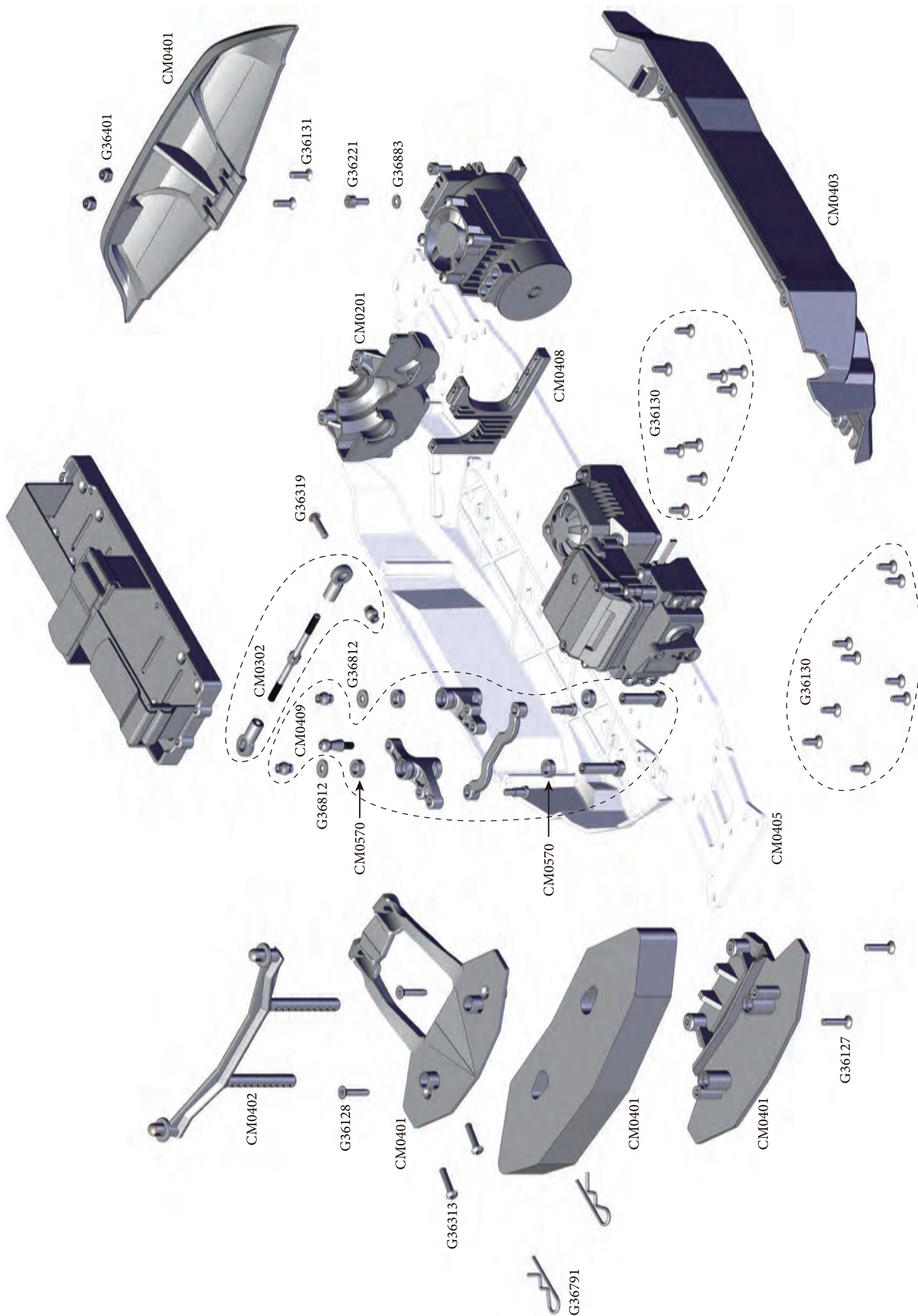

Upper Deck

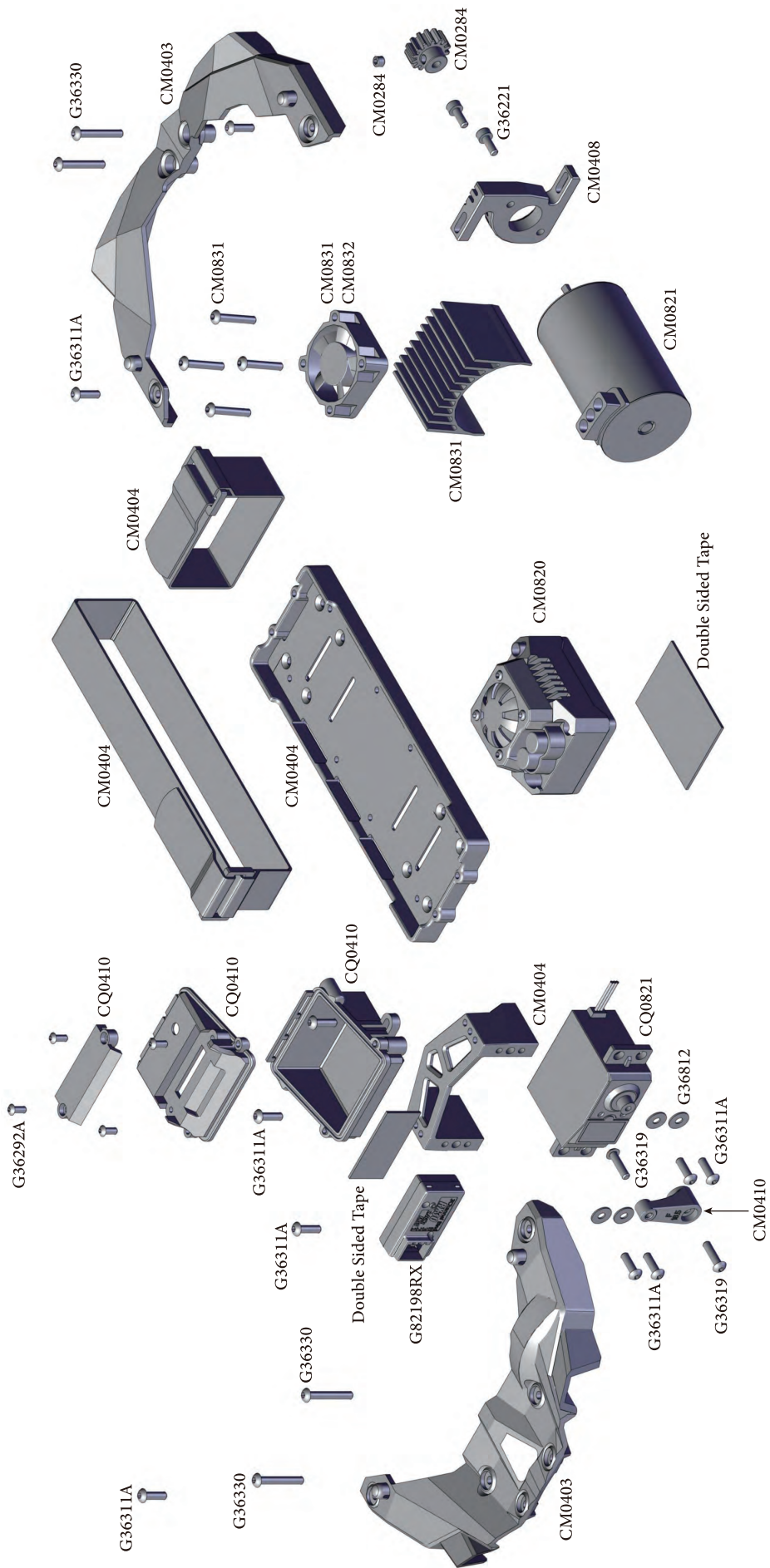



CM0101 Complete Shock Set, 2pcs.



CM0102 Shock O-Ring Re-build Kit



CM0103 Gear Box Set, (front, center, rear)



CM0202 Hub Carriers & Spindle Set
(F/R, wheel hex)



CM0203 Differential Ring Gear Set
(case, pin, o-ring, gasket)



CM0204 Differential Pinion Gear 17T



CM0205 Spur Gear 46T



CM0206 Wheel Axle & Drive Shaft (outdrive cups)



CM0207 Center Drive Shaft Set
(center F/R outdrive shaft, spacer, spur gear mount)



CM0284 Motor Pinion 14T 3.175mm bored



CM0301 Lower Suspension Arm (L/R, spacer)



CM0302 Turnbuckle & Ball End
(M3x33mm, M3x50mm, Pivot Ball)

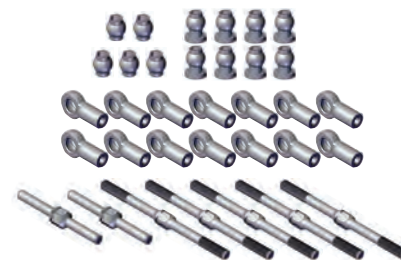

CM0401 Front Bumper & Rear Diffuser
(foam, body post extension)

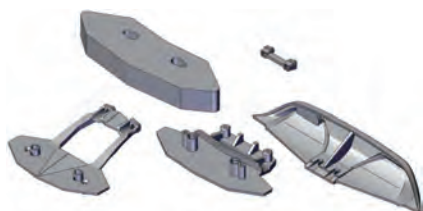

CM0402 Body Post Set



CM0403 Upper Deck & Side Guard Set



Spare Parts



CM0404 Battery Tray & Servo Mount



CM0405 Main Chassis



CM0406 Shock Tower, 2pcs.



CM0407 Lower Arm Brace & Sus. Arm Hinge Pin Set



CM0408 Motor Mount Set



CM0409 Steering Post Set



CM0410 Servo Horn, 23T, 24T, 25T Gear Spline



CM0501 High Performance Racing Tires
56 x 80 x 35.50 mm, 2pcs.



CM0601 WRC Racing Wheel 56 X 35.50 mm, 2pcs.



CM0750 Metal Ball Bearing Set



CM0820 ESC WP-MAX10 100A-3S-RTR



CM0821 Brushless Motor BL-3658 3000KV

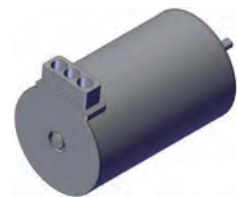

CM0831 Motor Heatsink & Fan Combo

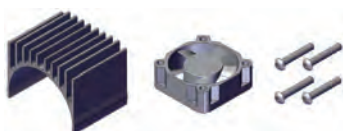

CM0832 30mm Hyper Cooling Fan
(JR-3P, ball bearing, 6-8.4V)



CM0901 2023 M-Sport Puma Complete Body Set.



CM0910 2023 M-Sport Puma Body Accessories Set
(mirror, wing, screws, etc.)

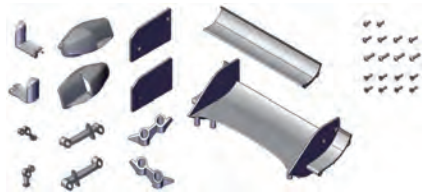

CQ0401 Receiver Box

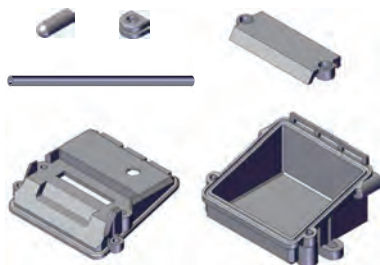

CQ0821 Savox RTR 12kg-cm Metal Gear Servo

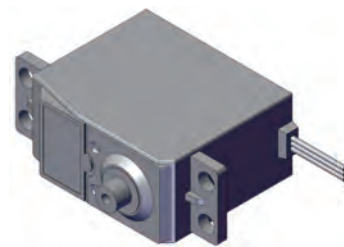

G36130
M3x8mm Flat Head Hex Socket Screw
(10pcs)



G36131
M3x10 Flat Head Hex Socket Screw
(10pcs)



G36221
M3x8mm Cap Screw
(10pcs)



G36260
M4x3mm Set Screw
(10pcs)

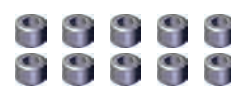

G36265
Screw Shaft M3x2.5x8mm
(10 pcs)



G36270
King Pin Screws (phillips)
10pcs



G36297
M2.5x10mm Button Head Hex Socket Screw
(10pcs)



G36311A
M3x10mm Button Head Hex Socket Screw
(10pcs)



G36313
M3x16mm Button Head Hex Socket Screw
(10pcs)



G36318
M3x8mm Button Head Hex Socket Screw
(10pcs)



G36319
M3x12mm Button Head Hex Socket Screw
(10pcs)



G36324
M3x14mm Button Head Hex Socket Screw
(10pcs)



G36325
M3x18mm Button Head Hex Socket Screw
(10pcs)



G36330
M3x20mm Button Head Hex Socket Screw
(10pcs)



G36401
M3 Nylon Insert Locknut
(10pcs)



G36401A
M3 Locknut
(10pcs)

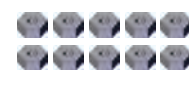

G36403A
M4 Nylon Insert Flange Locknut, Serrated
(4pcs)



G36701
Pin 2x10mm
(6pcs)



G36791
#6 Hood Pin
(10pcs)

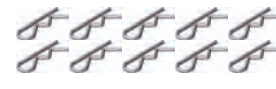

G36812
Washer M3x8x0.5
(6pcs)



G36883
Washer W3x6x0.5mm
(6pcs)



G36910
Shim W10x12.5x0.10mm
(10pcs)



G70303B
O-Ring P3 NBR
(10PCS)



Memo



WRC
FIA WORLD RALLY
CHAMPIONSHIP

M-SPORT



WORLD RALLY TEAM



CEN
RACING

Manufactured by
CEN Racing Co.
10F, No.11, Ln 122, Sec.2 Ganyuan St.
Shulin Dist, New Taipei City 23853, Taiwan
CENRACINGUSA.COM

14+

WARNING!

This radio controlled model car kit is not suitable for children under 14 years old as it contains many small parts which are potential choking hazards. Please take great caution and keep all components out of the reach of small and young children.

mit
MADE IN TAIWAN

